

▪ İKİ BORUYA MONTAJ (FLEX-GRIP)

Boru hattındaki Sorun

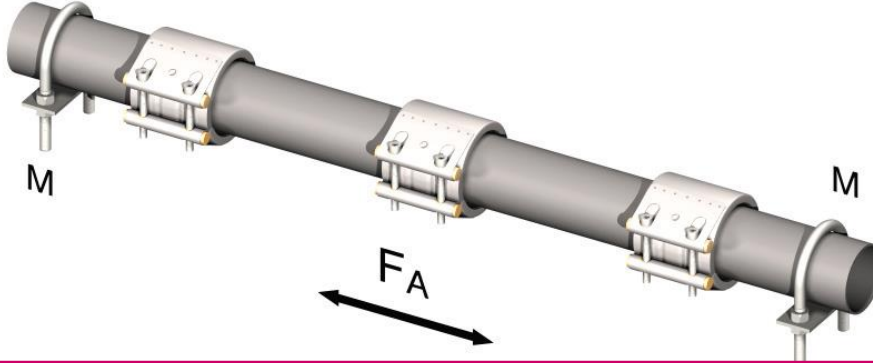

Borflex Cözüm



▪ BORUDA HASAR TAMİRİ (REP)

Boru hattındaki Sorun



Borflex Cözüm

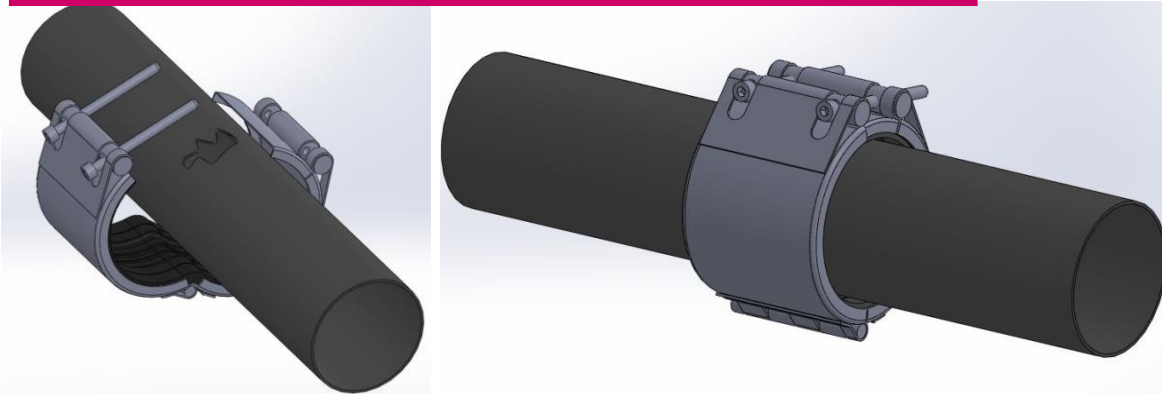

CONTADAN BÜYÜK HASARLARDA –BORUNUN
KESİLEREK ARAYA PARÇA KONMASI VE İKİ
ADET FLEX İLE TAMİR ÇİZİMLERİ

CONTA İÇİNDE KALACAK
HASARLARIN ÇİZİMİ

▪ BORUDA YATAY EKSEN HAREKETİ

Boru hattındaki Sorun

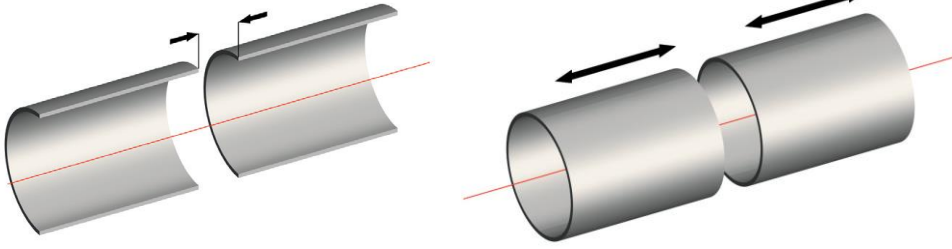

Borflex Cözüm



İKİ BORUYA MANŞON BAĞLI İKEN
UZAMA VE KISALMA POZİSYONLARINDA
MAX . EKSEN HAREKETİ GÖSTER

AYNI ÖZELLİĞİ GENİŞ TİP MANŞONDA DA
GÖSTER VE AVANTAJINI FOREKSİN BELİRT.

▪ BORUDA DİKEY EKSEN HAREKETİ

Boru hattındaki Sorun

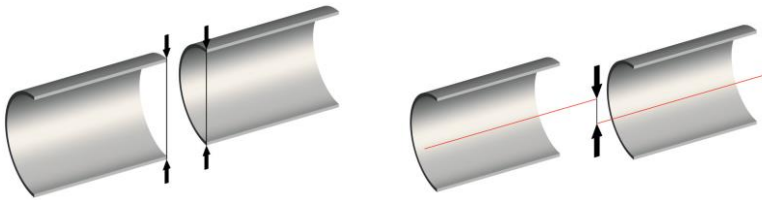

İKİ BORUYA
MANŞON BAĞLI İKEN
UZAMA VE KISALMA
POZİSYONLARINDA
MAX . DİKEY EKSEN
HAREKETİ GÖSTER

Borflex Cözüm



■ BORUDA AÇISAL HAREKET

Boru hattındaki Sorun

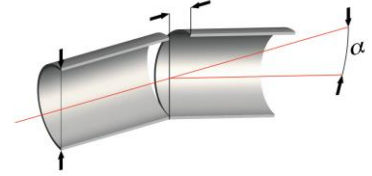
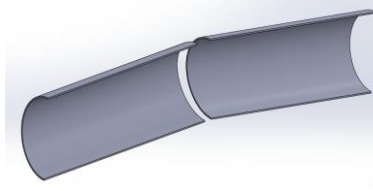

Borflex Cözüm



İKİ BORUYA
MANŞON BAĞLI
İKEN UZAMA VE
KISALMA
POZİSYONLARINDA
MAX . AÇIYI GÖSTER

■ BORULARDA ÇAP FARKLARI

Boru hattındaki Sorun

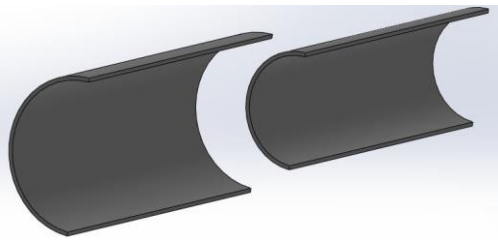

Borflex Cözüm



İKİ BORU DA ÇAP FARKINI
GÖSTER VE STEP MANŞON
BAĞLA MAX.ÇAP FARKINI
GÖSTER

**BORSTEP - FARKLI İKİ ÇAPIN
MONTAJ KELEPÇESİ**